

Shaft plan view

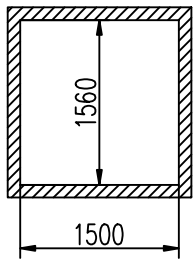

M= An additional 50 mm for clear structural opening is required.

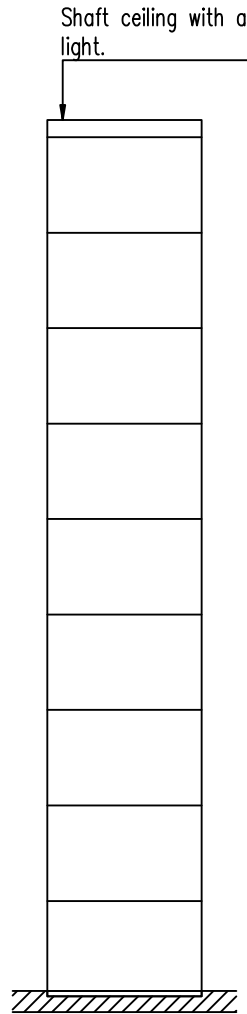
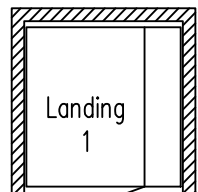
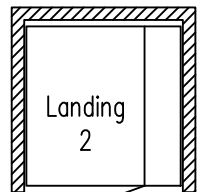
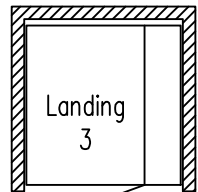

Side C

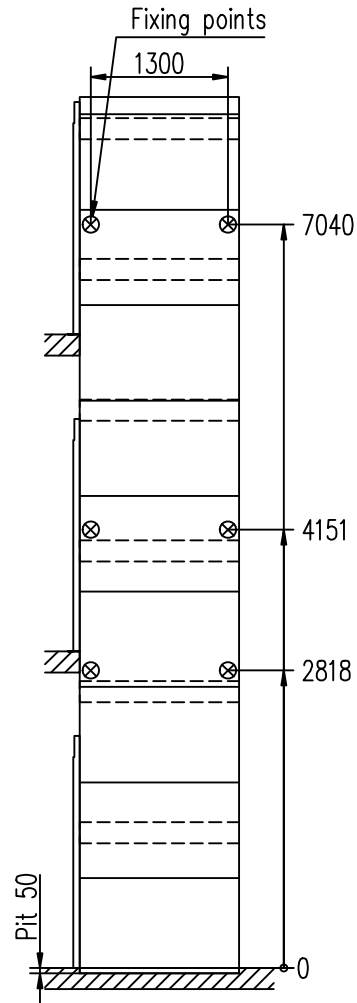

Side D

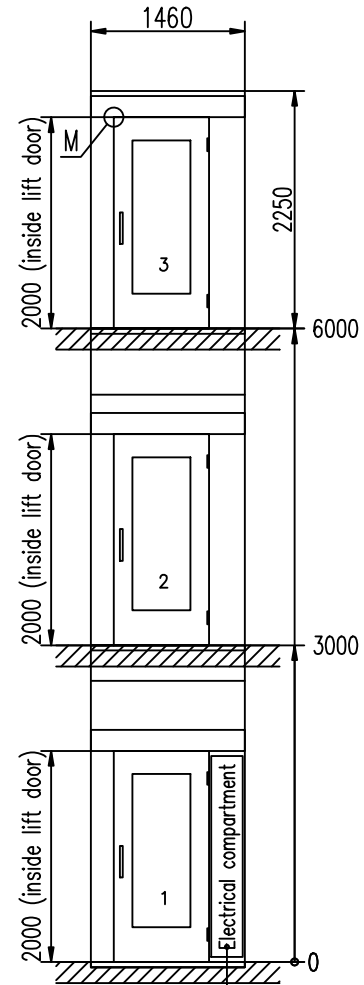

Side A

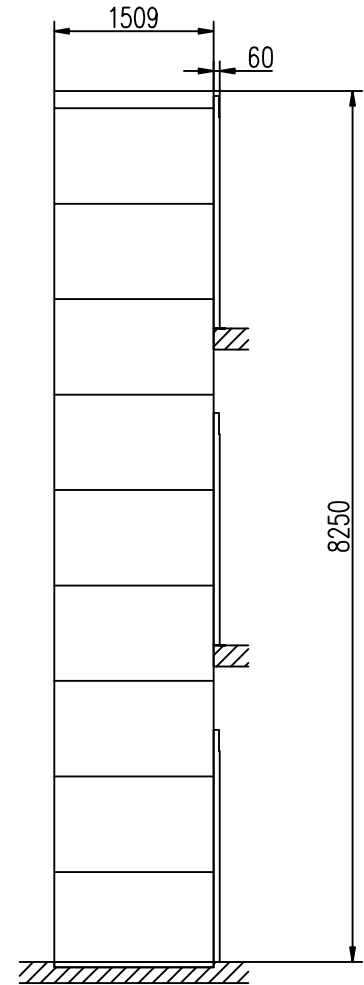

Side B

Access required for compartment cover

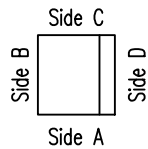

Drawn
Constr.

Shaftwall A 5000

Scale
1: 47

File name
108892-W

Date
14-09-11

Dwg-nr

Sheet

1