

Shaft plan view

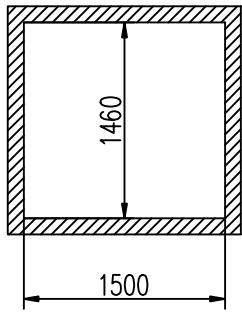

M= An additional 50 mm for clear structural opening is required.

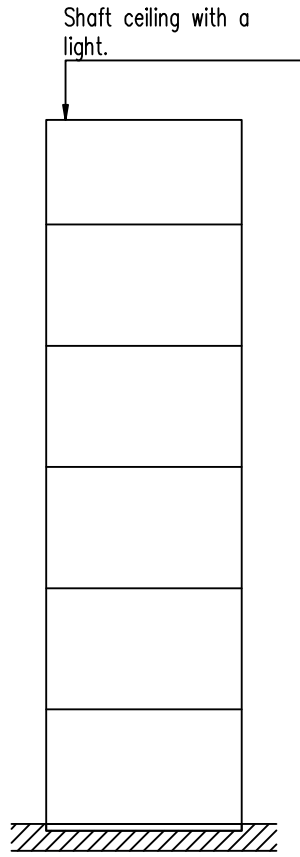
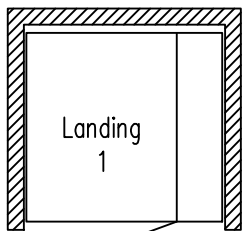
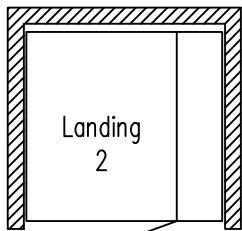

Side C

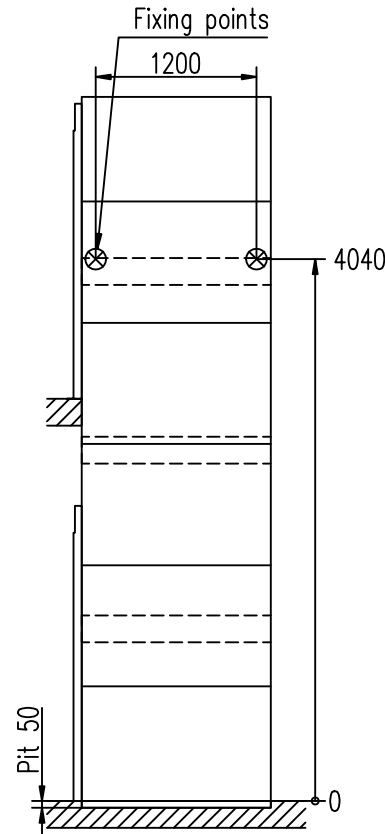

Side D

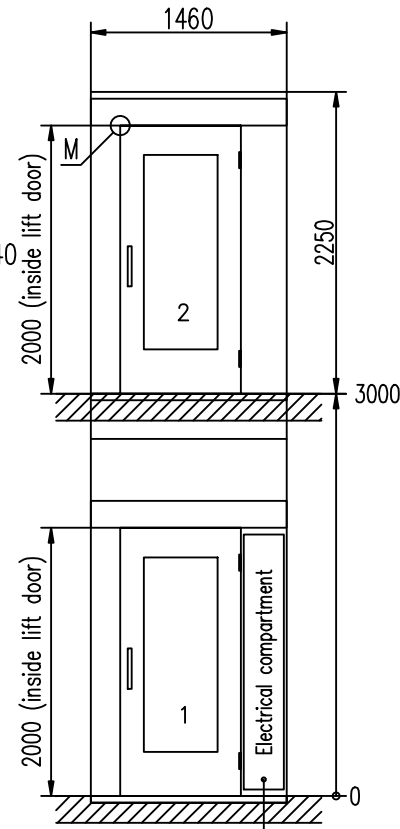

Side A

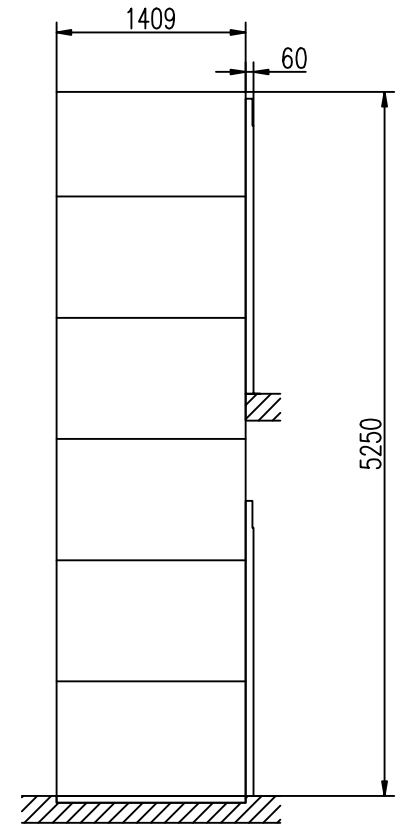

Side B

Access required for compartment cover

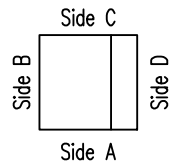

Drawn Shaftwall A 5000

Constr.

Scale File name 108699-W

1:37 Date 14-09-08

Dwg-nr Sheet 1