

Shaft plan view

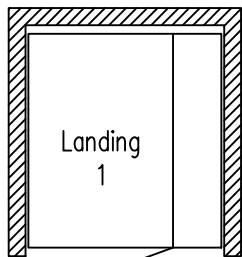

M= An additional 50 mm for clear structural opening is required.

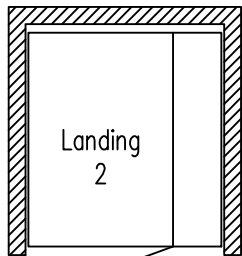
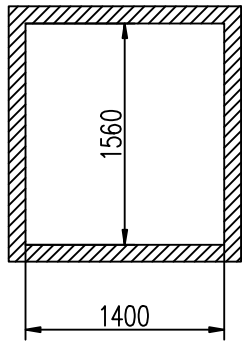
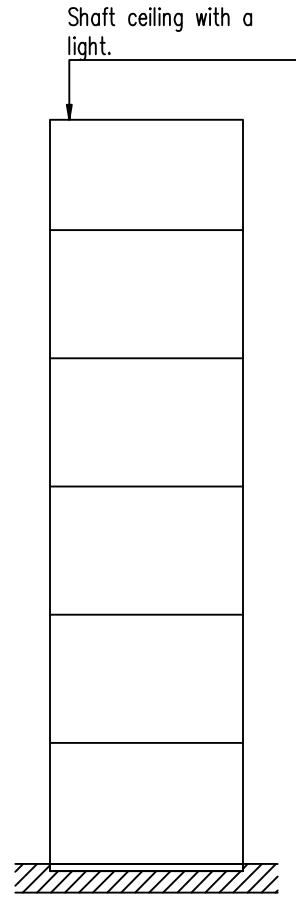

Side C

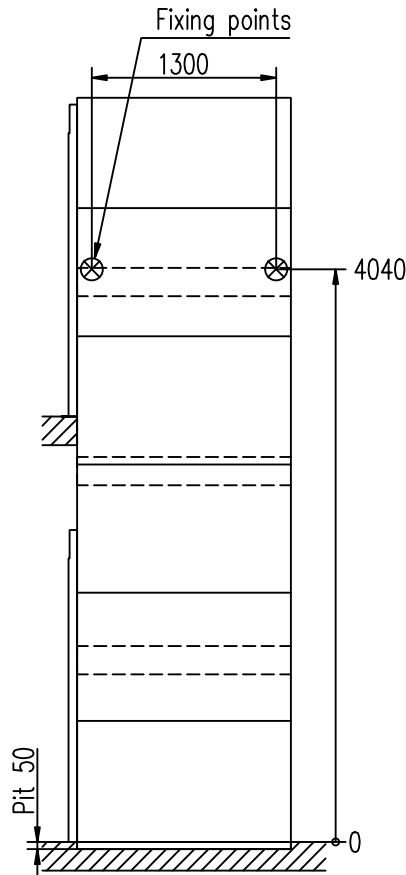

Side D

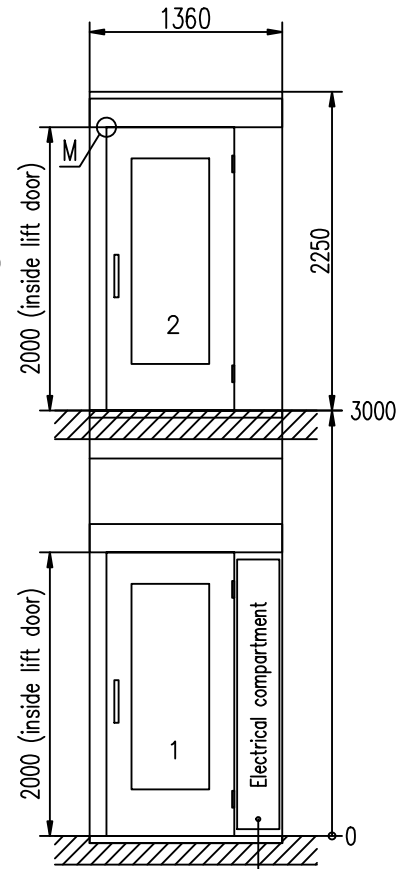

Side A

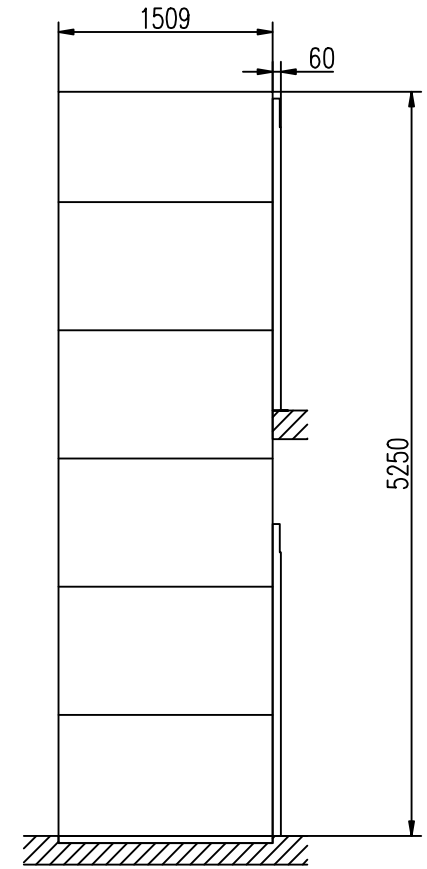

Side B

Access required for compartment cover

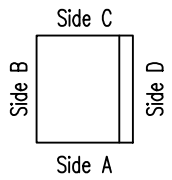

Drawn
Constr.
Shaftwall A 5000

Scale	File name
1:35	108684-W
Dwg-nr	Date
	14-09-08
	Sheet
	1