

M= An additional 50 mm for clear structural opening is required.

Shaft plan view

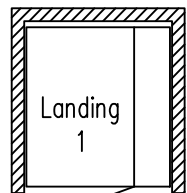

Shaft ceiling with a light.

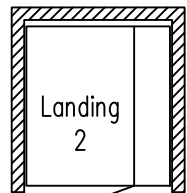
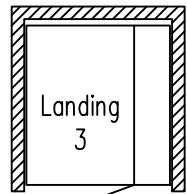
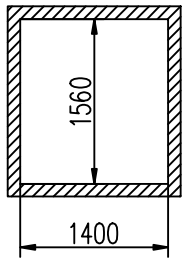
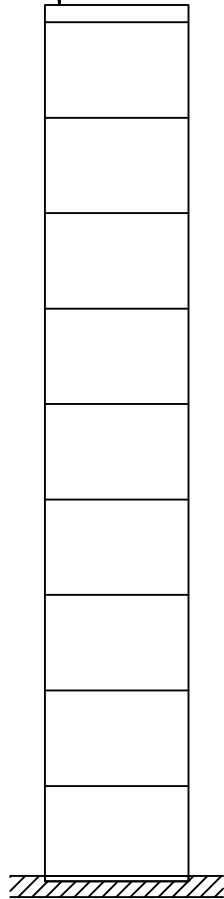

Side C

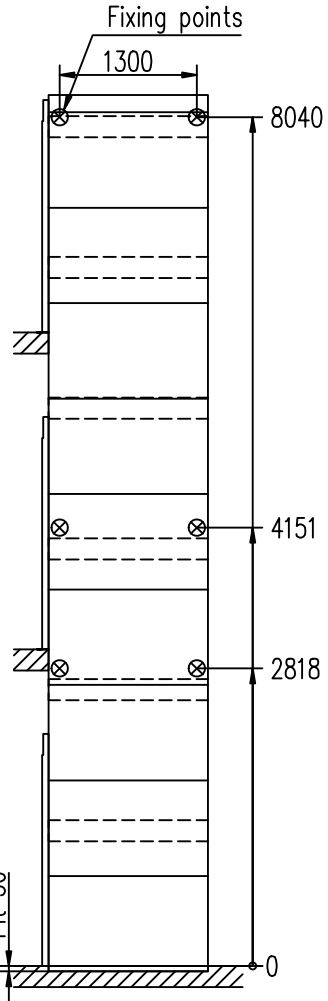

Side D

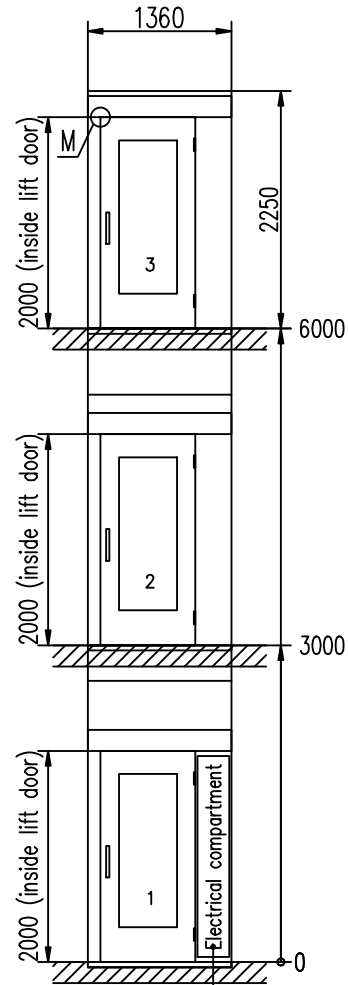

Side A

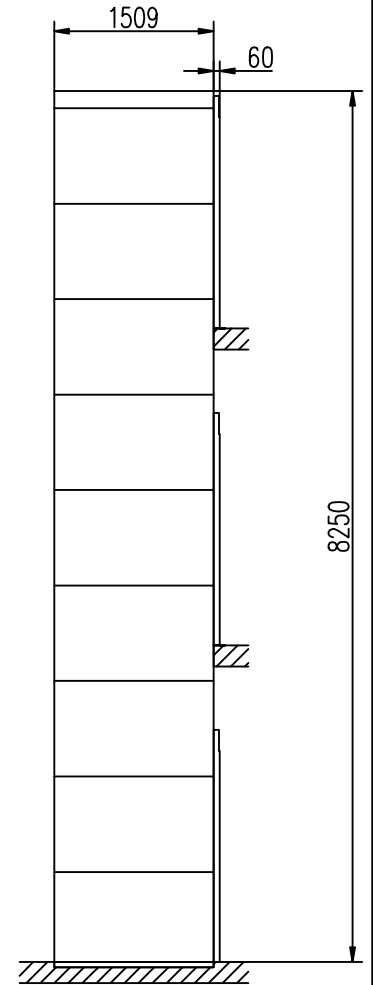

Side B

Access required for compartment cover

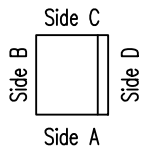

Drawn Shaftwall A 7000

Constr.

Scale File name 108694-W

1:47 Date 14-09-08

Dwg-nr Sheet 1