

Shaft plan view

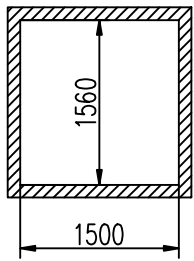

M= An additional 50 mm for clear structural opening is required.

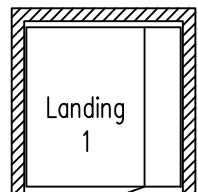
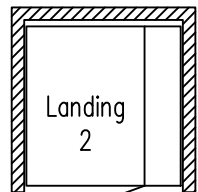
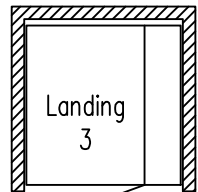

Shaft ceiling with a light.

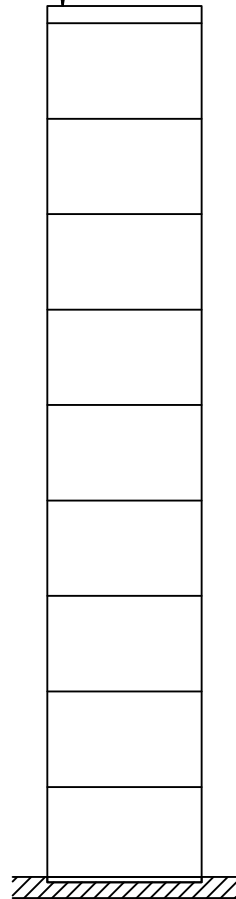

Side C

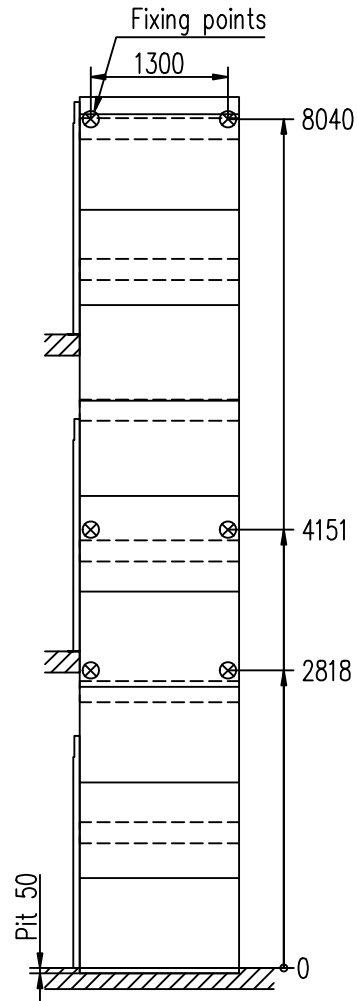

Side D

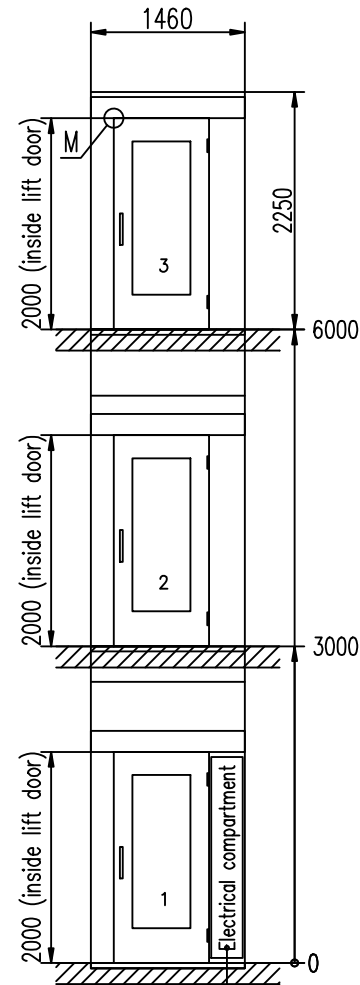

Side A

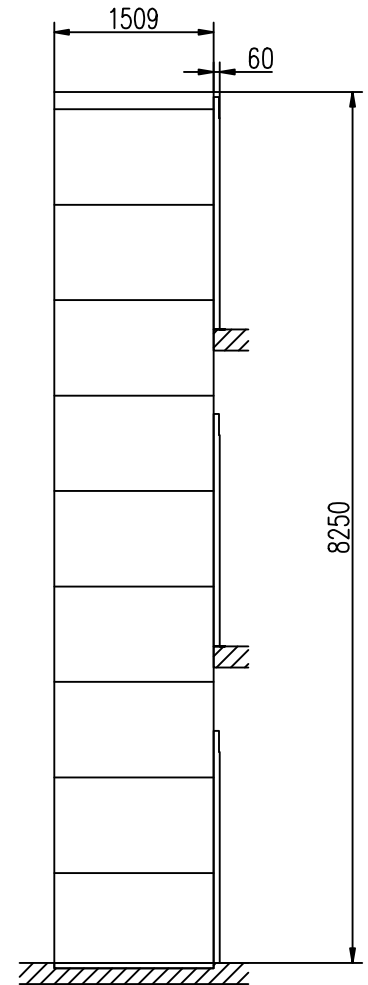

Side B

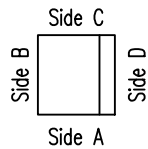

Access required for compartment cover



Drawn
Constr.

Shaftwall A 7000

Scale
1: 47

File name
108894-W

Date
14-09-11

Dwg-nr

Sheet

1